



# TOUCH<sup>TM</sup>

Quick Start & Troubleshooting Guide



- GB** Quick Start and Troubleshooting Guide
- F** Quick Start and Troubleshooting Guide
- D** Quick Start and Troubleshooting Guide
- I** Quick Start and Troubleshooting Guide
- ESP** Quick Start and Troubleshooting Guide
- DK** Quick Start and Troubleshooting Guide
- S** Quick Start and Troubleshooting Guide

GB

# Quick Start Guide

Please follow these instructions to ensure the correct setup and use of your new electric trolley.

For further information please contact us below or visit our website [www.powakaddy.com](http://www.powakaddy.com)

PowaKaddy International Ltd  
Castle Road  
Sittingbourne  
Kent  
ME10 3RN

[sales@powakaddy.com](mailto:sales@powakaddy.com)

+ 44 (0) 1795 473 555

1

**\*You will need to put your battery on charge straight away.\***

Before you play a round it will need a full 12 hour charge minimum.

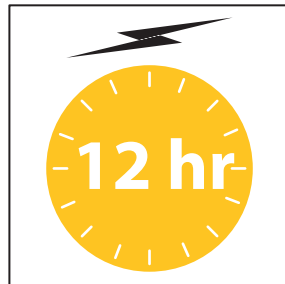
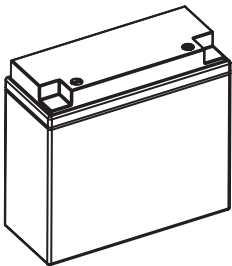

2

Next fit your wheels; simply slide the wheel onto the spindle, press the yellow button and click home.

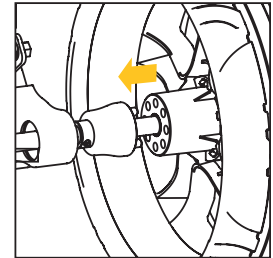
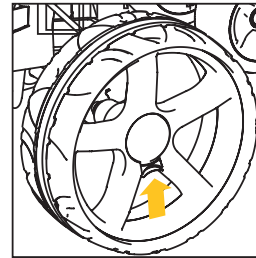

2a

## Wheel Positions

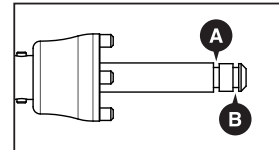

**Groove A.** Wheels will be powered by the motor.

**Groove B.** Wheels will be free wheeling and not powered by the motor.

3

To unfold the trolley, pull the handle up in one motion. The trolley will unfold, at this point the bag stay can be raised.

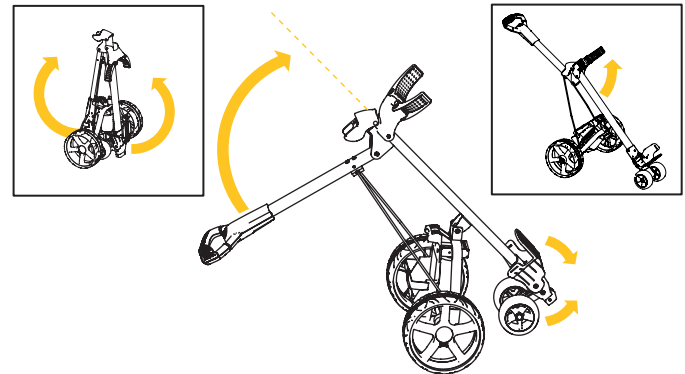

**4** The handle can be set at two heights. Ensure the latch (Fig A.) has sprung into position to lock the handle at the correct height.

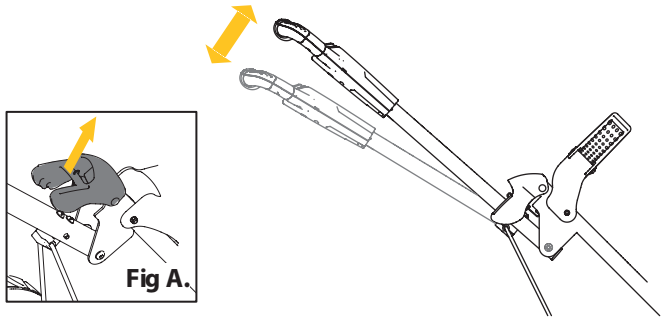

**5** To open the front wheels simply open the bag stay as shown below. The front wheels will automatically move into position.

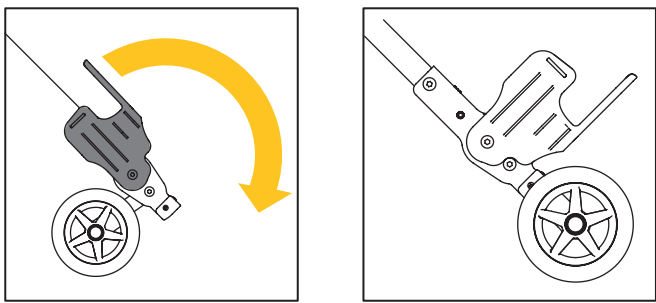

**6** Next place your battery in position shown below and connect.

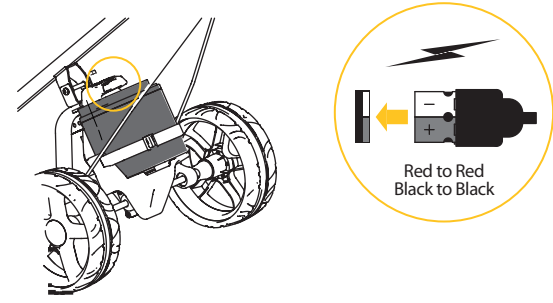

**7** Turn on the trolley by pressing the power button located on the right side of the handle tube.

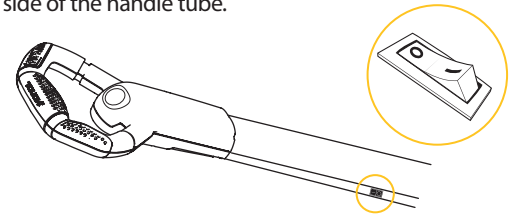

**8** To start the trolley pull back all the way on the handle, the trolley is now ready to go. Move the handle forward to increase the speed of the trolley and pull back to decrease.

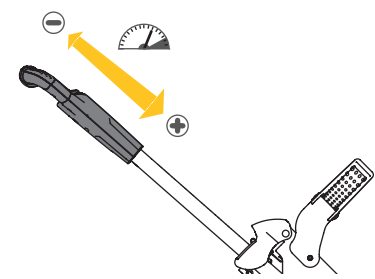

# Troubleshooting Guide

**1 Problem:** My trolley doesn't start

## Solution

- 1:1. Ensure the switch is turned on.
- 1:2. Check your battery is fully charged and connected correctly.
- 1:3. Pull the handle all the way back to the "stop" position and push it forward again.
- 1:4. Check all the external leads are connected.

**If the above doesn't solve the problem contact your nearest service agent.**

**2 Problem:** My trolley will not stop

## Solution

- 2:1. Pull the handle all the way back to the "stop" position.

**If this does not correct the problem, turn the trolley off via the switch, or disconnect the battery and contact your nearest service agent.**

**3 Problem:** The lower bag stay gear mechanism is jammed or does not operate

## Solution

- 3:1. Remove any mud or debris clogging the wheel mechanism.

**If the above doesn't solve the problem contact your nearest service agent.**

**4 Problem:** My trolley doesn't run straight

## Solution

- 4:1. Remove any mud or debris clogging the wheel mechanism.
- 4:2. The front wheel alignment can be adjusted using a standard 4mm Hex key also known as an 'Allen Key' (included). There are two hex screws visible by the lower bag stay, one each side, which when tightened or loosened angle the front wheels left to right.

*4:2:1. To angle the wheels right loosen the left screw clockwise and then tighten the right screw anti-clockwise.*

*4:2:2. To angle the wheels left loosen the right screw clockwise and then tighten the left screw anti-clockwise.*

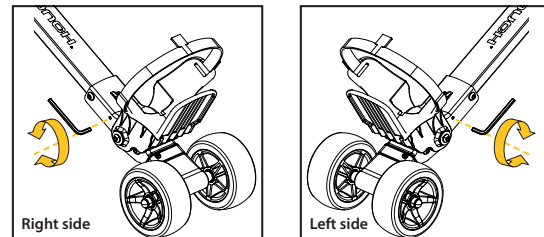

**If the above doesn't solve the problem contact your nearest service agent.**

To find your nearest service agent visit [www.powakaddy.com](http://www.powakaddy.com)

# Quick Start Guide

Please follow these instructions to ensure the correct setup and use of your new electric trolley.

For further information please contact us below or visit our website [www.powakaddy.com](http://www.powakaddy.com)

PowaKaddy International Ltd  
Castle Road  
Sittingbourne  
Kent  
ME10 3RN

[sales@powakaddy.com](mailto:sales@powakaddy.com)

+ 44 (0) 1795 473 555

1

**\*You will need to put your battery on charge straight away.\***

Before you play a round it will need a full 12 hour charge minimum.

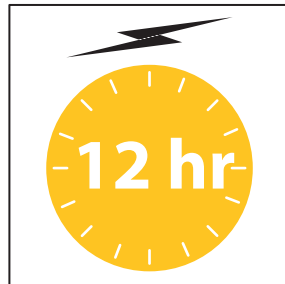
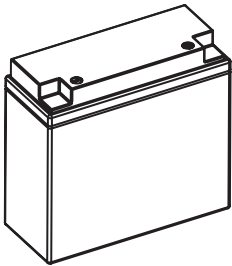

2

Next fit your wheels; simply slide the wheel onto the spindle, press the yellow button and click home.

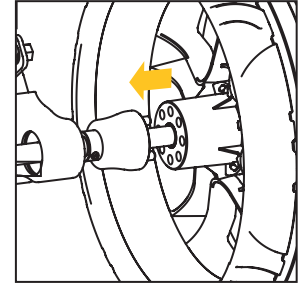
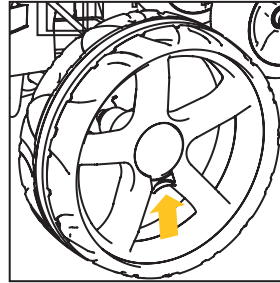

3

To unfold the trolley, pull the handle up in one motion. The trolley will unfold, at this point the bag stay can be raised.

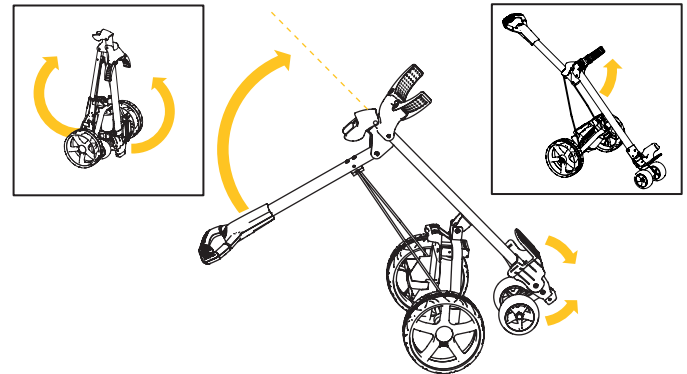

- 4 The handle can be set at two heights. Ensure the latch (Fig A.) has sprung into position to lock the handle at the correct height.

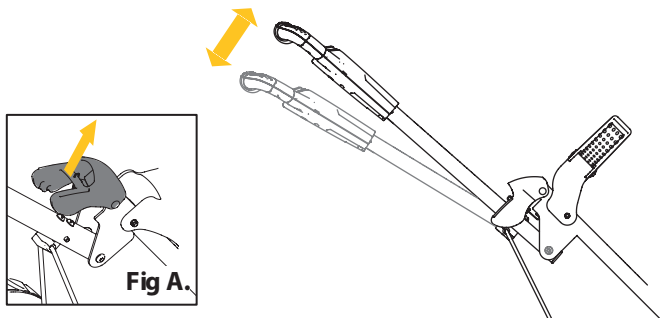

- 5 To open the front wheels simply open the bag stay as shown below. The front wheels will automatically move into position.

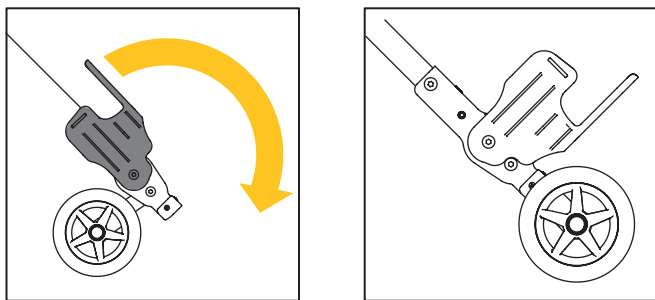

- 6 Next place your battery in position shown below and connect.

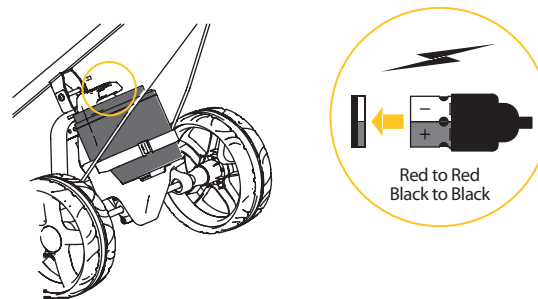

- 7 Turn on the trolley by pressing the power button located on the right side of the handle tube.

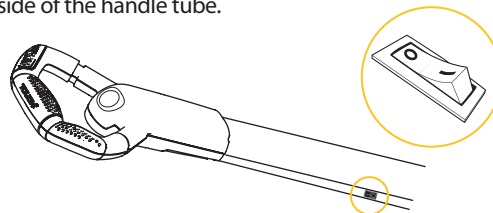

- 8 To start the trolley pull back all the way on the handle, the trolley is now ready to go. Move the handle forward to increase the speed of the trolley and pull back to decrease.

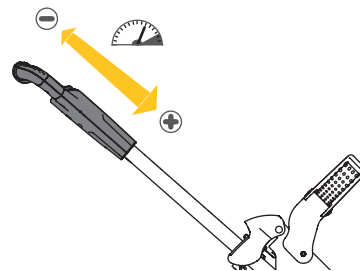



# Troubleshooting Guide

**1 Problem:** My trolley doesn't start

## Solution

- 1:1. Ensure the switch is turned on.
- 1:2. Check your battery is fully charged and connected correctly.
- 1:3. Pull the handle all the way back to the "stop" position and push it forward again.
- 1:4. Check all the external leads are connected.

**If the above doesn't solve the problem contact your nearest service agent.**

**2 Problem:** My trolley will not stop

## Solution

- 2:1. Pull the handle all the way back to the "stop" position.

**If this does not correct the problem, turn the trolley off via the switch, or disconnect the battery and contact your nearest service agent.**

**3 Problem:** The lower bag stay gear mechanism is jammed or does not operate

## Solution

- 3:1. Remove any mud or debris clogging the wheel mechanism.

**If the above doesn't solve the problem contact your nearest service agent.**

**4 Problem:** My trolley doesn't run straight

## Solution

- 4:1. Remove any mud or debris clogging the wheel mechanism.
- 4:2. The front wheel alignment can be adjusted using a standard 4mm Hex key also known as an 'Allen Key' (included). There are two hex screws visible by the lower bag stay, one each side, which when tightened or loosened angle the front wheels left to right.
  - 4:2:1. To angle the wheels right loosen the left screw clockwise and then tighten the right screw anti-clockwise.
  - 4:2:2. To angle the wheels left loosen the right screw clockwise and then tighten the left screw anti-clockwise.

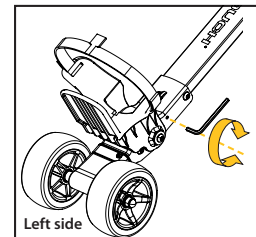
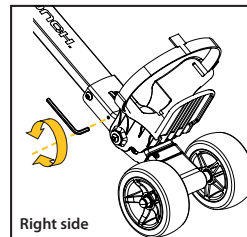

**If the above doesn't solve the problem contact your nearest service agent.**

To find your nearest service agent visit [www.powakaddy.com](http://www.powakaddy.com)

D

# Quick Start Guide

Please follow these instructions to ensure the correct setup and use of your new electric trolley.

For further information please contact us below or visit our website [www.powakaddy.com](http://www.powakaddy.com)

PowaKaddy International Ltd  
Castle Road  
Sittingbourne  
Kent  
ME10 3RN

[sales@powakaddy.com](mailto:sales@powakaddy.com)

+ 44 (0) 1795 473 555

1

**\*You will need to put your battery on charge straight away.\***

Before you play a round it will need a full 12 hour charge minimum.

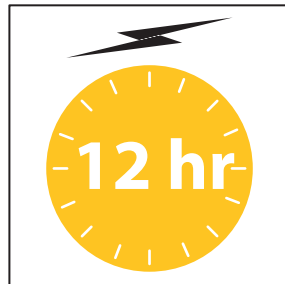
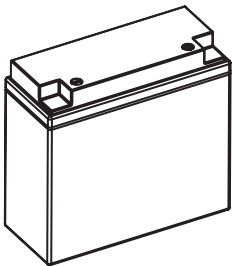

2

Next fit your wheels; simply slide the wheel onto the spindle, press the yellow button and click home.

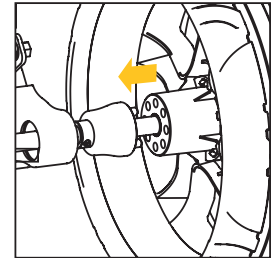
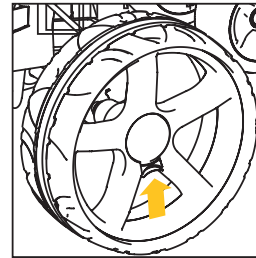

2a

**Wheel Positions**

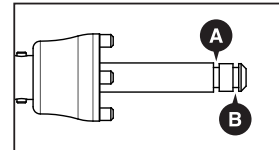

**Groove A.** Wheels will be powered by the motor.

**Groove B.** Wheels will be free wheeling and not powered by the motor.

3

To unfold the trolley, pull the handle up in one motion. The trolley will unfold, at this point the bag stay can be raised.

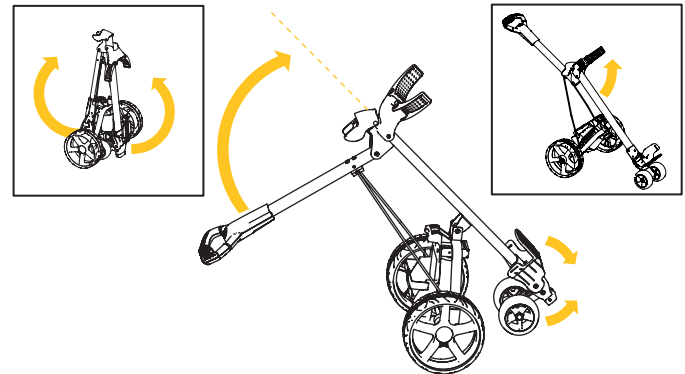

- 4 The handle can be set at two heights. Ensure the latch (Fig A.) has sprung into position to lock the handle at the correct height.

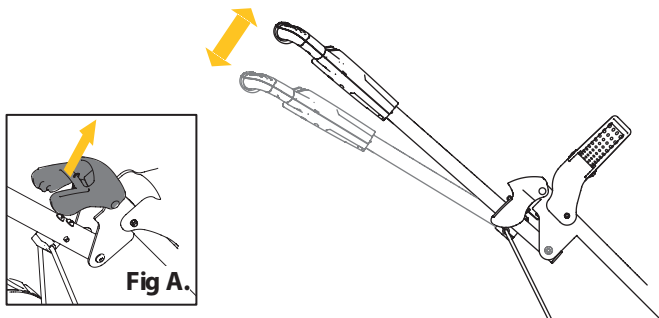

- 5 To open the front wheels simply open the bag stay as shown below. The front wheels will automatically move into position.

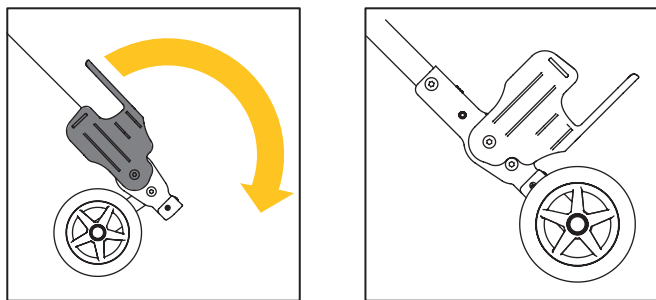

- 6 Next place your battery in position shown below and connect.

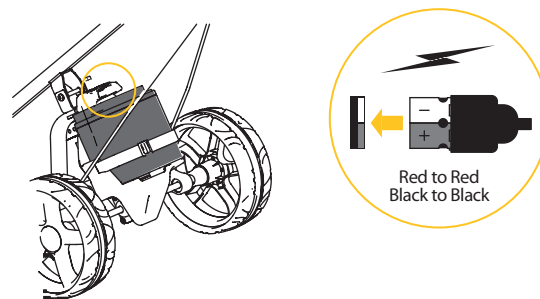

- 7 Turn on the trolley by pressing the power button located on the right side of the handle tube.

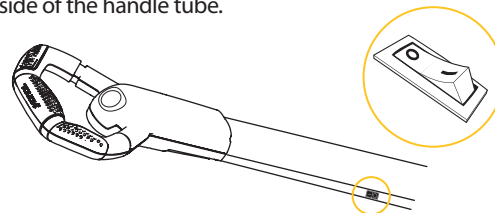

- 8 To start the trolley pull back all the way on the handle, the trolley is now ready to go. Move the handle forward to increase the speed of the trolley and pull back to decrease.

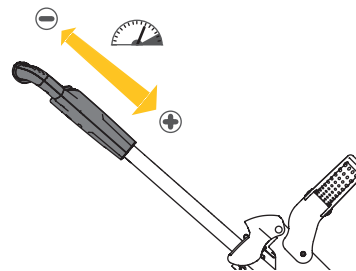

# Troubleshooting Guide

**1 Problem:** My trolley doesn't start

## Solution

- 1:1. Ensure the switch is turned on.
- 1:2. Check your battery is fully charged and connected correctly.
- 1:3. Pull the handle all the way back to the "stop" position and push it forward again.
- 1:4. Check all the external leads are connected.

**If the above doesn't solve the problem contact your nearest service agent.**

**2 Problem:** My trolley will not stop

## Solution

- 2:1. Pull the handle all the way back to the "stop" position.

**If this does not correct the problem, turn the trolley off via the switch, or disconnect the battery and contact your nearest service agent.**

**3 Problem:** The lower bag stay gear mechanism is jammed or does not operate

## Solution

- 3:1. Remove any mud or debris clogging the wheel mechanism.

**If the above doesn't solve the problem contact your nearest service agent.**

**4 Problem:** My trolley doesn't run straight

## Solution

- 4:1. Remove any mud or debris clogging the wheel mechanism.
- 4:2. The front wheel alignment can be adjusted using a standard 4mm Hex key also known as an 'Allen Key' (included). There are two hex screws visible by the lower bag stay, one each side, which when tightened or loosened angle the front wheels left to right.

*4:2:1. To angle the wheels right loosen the left screw clockwise and then tighten the right screw anti-clockwise.*

*4:2:2. To angle the wheels left loosen the right screw clockwise and then tighten the left screw anti-clockwise.*

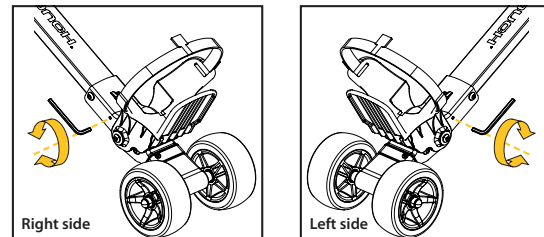

**If the above doesn't solve the problem contact your nearest service agent.**

To find your nearest service agent visit [www.powakaddy.com](http://www.powakaddy.com)

1

# Quick Start Guide

Please follow these instructions to ensure the correct setup and use of your new electric trolley.

For further information please contact us below or visit our website [www.powakaddy.com](http://www.powakaddy.com)

PowaKaddy International Ltd  
Castle Road  
Sittingbourne  
Kent  
ME10 3RN

[sales@powakaddy.com](mailto:sales@powakaddy.com)

+ 44 (0) 1795 473 555

1

**\*You will need to put your battery on charge straight away.\***

Before you play a round it will need a full 12 hour charge minimum.

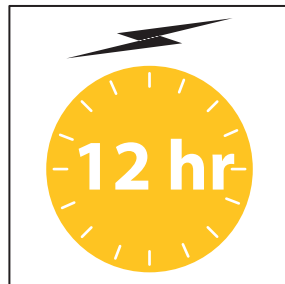
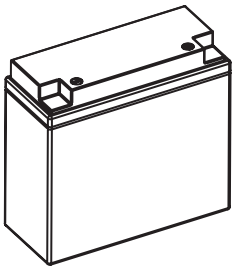

2

Next fit your wheels; simply slide the wheel onto the spindle, press the yellow button and click home.

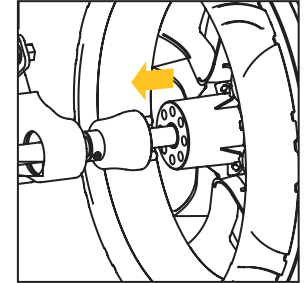
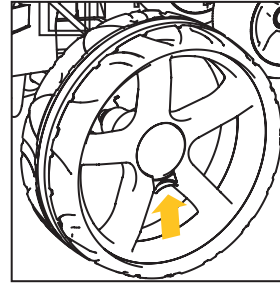

3

To unfold the trolley, pull the handle up in one motion. The trolley will unfold, at this point the bag stay can be raised.

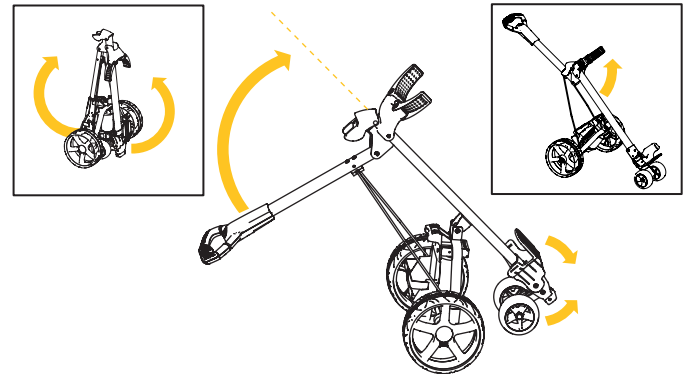

- 4 The handle can be set at two heights. Ensure the latch (Fig A.) has sprung into position to lock the handle at the correct height.

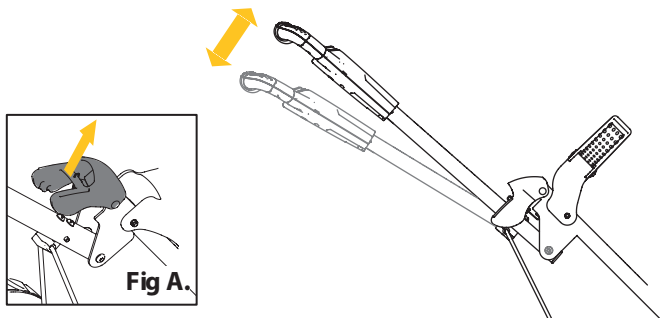

- 5 To open the front wheels simply open the bag stay as shown below. The front wheels will automatically move into position.

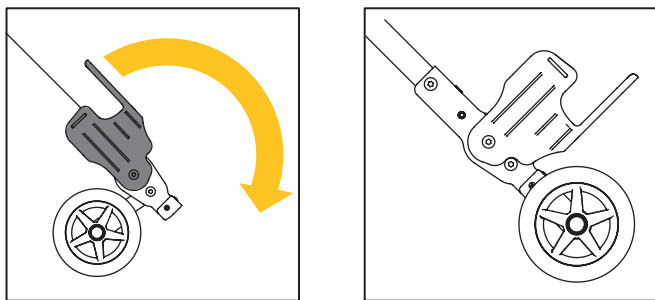

- 6 Next place your battery in position shown below and connect.

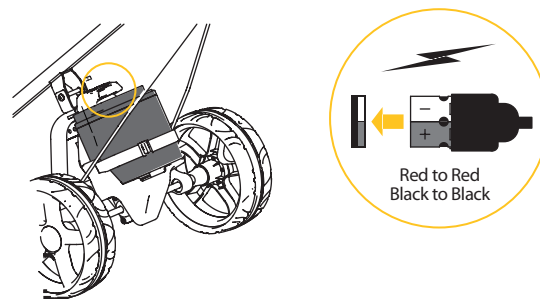

- 7 Turn on the trolley by pressing the power button located on the right side of the handle tube.

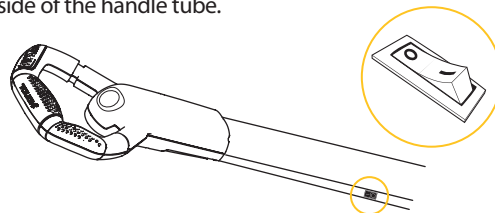

- 8 To start the trolley pull back all the way on the handle, the trolley is now ready to go. Move the handle forward to increase the speed of the trolley and pull back to decrease.

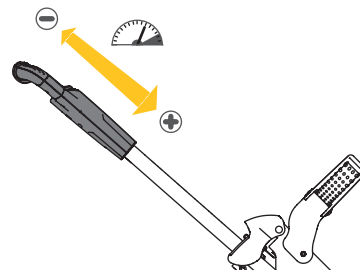

# Troubleshooting Guide

**1 Problem:** My trolley doesn't start

## Solution

- 1:1. Ensure the switch is turned on.
- 1:2. Check your battery is fully charged and connected correctly.
- 1:3. Pull the handle all the way back to the "stop" position and push it forward again.
- 1:4. Check all the external leads are connected.

**If the above doesn't solve the problem contact your nearest service agent.**

**2 Problem:** My trolley will not stop

## Solution

- 2:1. Pull the handle all the way back to the "stop" position.

**If this does not correct the problem, turn the trolley off via the switch, or disconnect the battery and contact your nearest service agent.**

**3 Problem:** The lower bag stay gear mechanism is jammed or does not operate

## Solution

- 3:1. Remove any mud or debris clogging the wheel mechanism.

**If the above doesn't solve the problem contact your nearest service agent.**

**4 Problem:** My trolley doesn't run straight

## Solution

- 4:1. Remove any mud or debris clogging the wheel mechanism.
- 4:2. The front wheel alignment can be adjusted using a standard 4mm Hex key also known as an 'Allen Key' (included). There are two hex screws visible by the lower bag stay, one each side, which when tightened or loosened angle the front wheels left to right.
  - 4:2:1. To angle the wheels right loosen the left screw clockwise and then tighten the right screw anti-clockwise.
  - 4:2:2. To angle the wheels left loosen the right screw clockwise and then tighten the left screw anti-clockwise.

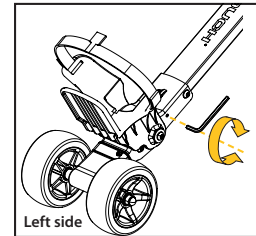
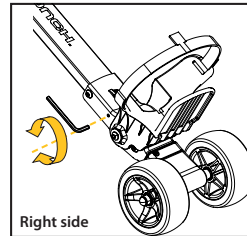

**If the above doesn't solve the problem contact your nearest service agent.**

To find your nearest service agent visit [www.powakaddy.com](http://www.powakaddy.com)

ESP

# Quick Start Guide

Please follow these instructions to ensure the correct setup and use of your new electric trolley.

For further information please contact us below or visit our website [www.powakaddy.com](http://www.powakaddy.com)

PowaKaddy International Ltd  
Castle Road  
Sittingbourne  
Kent  
ME10 3RN

[sales@powakaddy.com](mailto:sales@powakaddy.com)

+ 44 (0) 1795 473 555

1

**\*You will need to put your battery on charge straight away.\***

Before you play a round it will need a full 12 hour charge minimum.

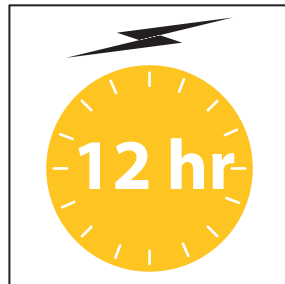
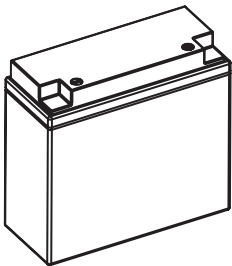

2

Next fit your wheels; simply slide the wheel onto the spindle, press the yellow button and click home.

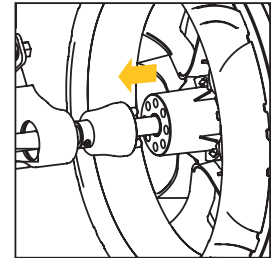
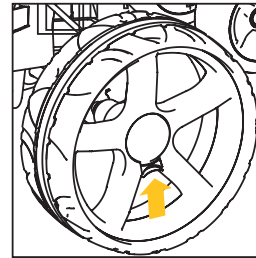

2a

**Wheel Positions**

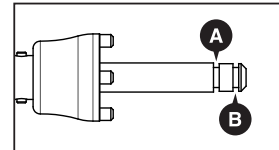

**Groove A.** Wheels will be powered by the motor.

**Groove B.** Wheels will be free wheeling and not powered by the motor.

3

To unfold the trolley, pull the handle up in one motion. The trolley will unfold, at this point the bag stay can be raised.

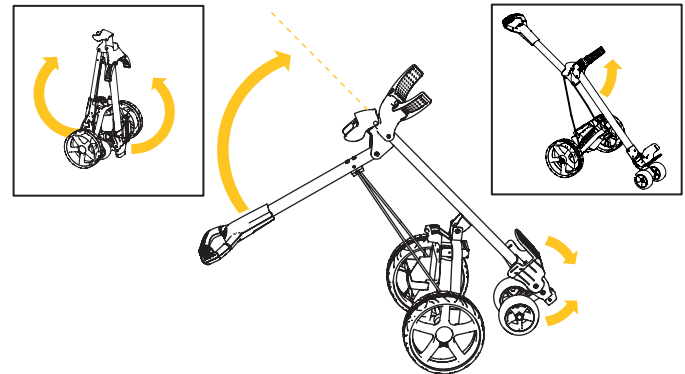



- 4 The handle can be set at two heights. Ensure the latch (Fig A.) has sprung into position to lock the handle at the correct height.

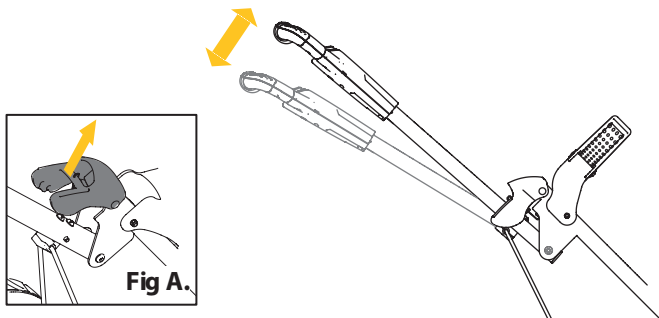

- 5 To open the front wheels simply open the bag stay as shown below. The front wheels will automatically move into position.

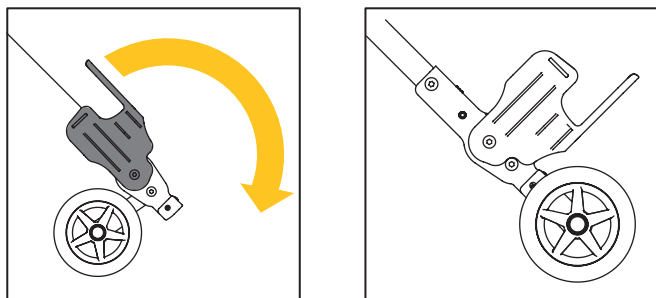

- 6 Next place your battery in position shown below and connect.

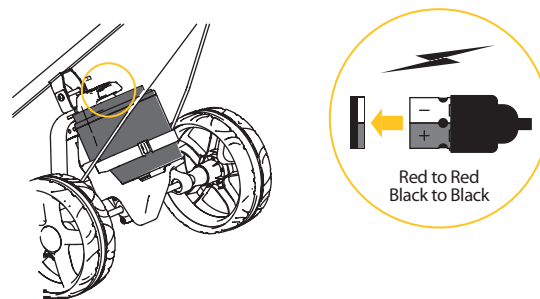

- 7 Turn on the trolley by pressing the power button located on the right side of the handle tube.

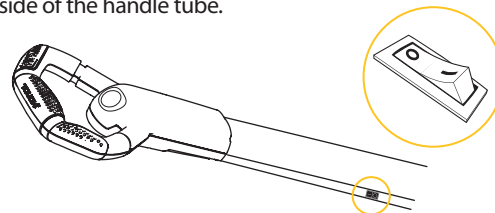

- 8 To start the trolley pull back all the way on the handle, the trolley is now ready to go. Move the handle forward to increase the speed of the trolley and pull back to decrease.

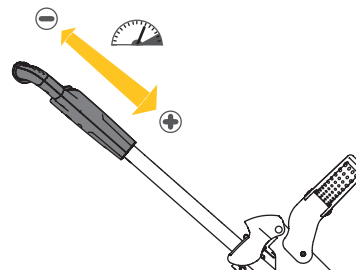

# Troubleshooting Guide

**1 Problem:** My trolley doesn't start

## Solution

- 1:1. Ensure the switch is turned on.
- 1:2. Check your battery is fully charged and connected correctly.
- 1:3. Pull the handle all the way back to the "stop" position and push it forward again.
- 1:4. Check all the external leads are connected.

**If the above doesn't solve the problem contact your nearest service agent.**

**2 Problem:** My trolley will not stop

## Solution

- 2:1. Pull the handle all the way back to the "stop" position.

**If this does not correct the problem, turn the trolley off via the switch, or disconnect the battery and contact your nearest service agent.**

**3 Problem:** The lower bag stay gear mechanism is jammed or does not operate

## Solution

- 3:1. Remove any mud or debris clogging the wheel mechanism.

**If the above doesn't solve the problem contact your nearest service agent.**

**4 Problem:** My trolley doesn't run straight

## Solution

- 4:1. Remove any mud or debris clogging the wheel mechanism.
- 4:2. The front wheel alignment can be adjusted using a standard 4mm Hex key also known as an 'Allen Key' (included). There are two hex screws visible by the lower bag stay, one each side, which when tightened or loosened angle the front wheels left to right.

*4:2:1. To angle the wheels right loosen the left screw clockwise and then tighten the right screw anti-clockwise.*

*4:2:2. To angle the wheels left loosen the right screw clockwise and then tighten the left screw anti-clockwise.*

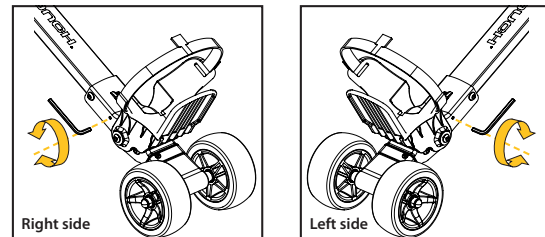

**If the above doesn't solve the problem contact your nearest service agent.**

To find your nearest service agent visit [www.powakaddy.com](http://www.powakaddy.com)

DK

# Quick Start Guide

Please follow these instructions to ensure the correct setup and use of your new electric trolley.

For further information please contact us below or visit our website [www.powakaddy.com](http://www.powakaddy.com)

PowaKaddy International Ltd  
Castle Road  
Sittingbourne  
Kent  
ME10 3RN

[sales@powakaddy.com](mailto:sales@powakaddy.com)

+ 44 (0) 1795 473 555

1

**\*You will need to put your battery on charge straight away.\***

Before you play a round it will need a full 12 hour charge minimum.

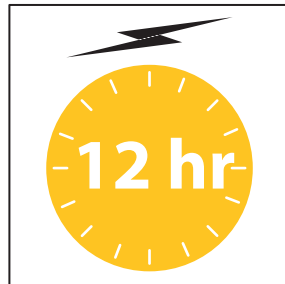
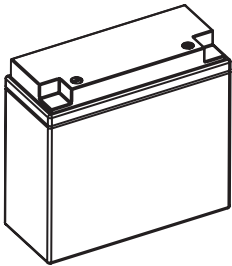

2

Next fit your wheels; simply slide the wheel onto the spindle, press the yellow button and click home.

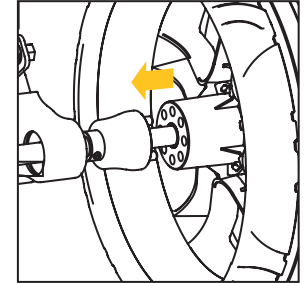
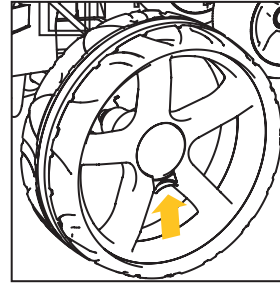

3

To unfold the trolley, pull the handle up in one motion. The trolley will unfold, at this point the bag stay can be raised.

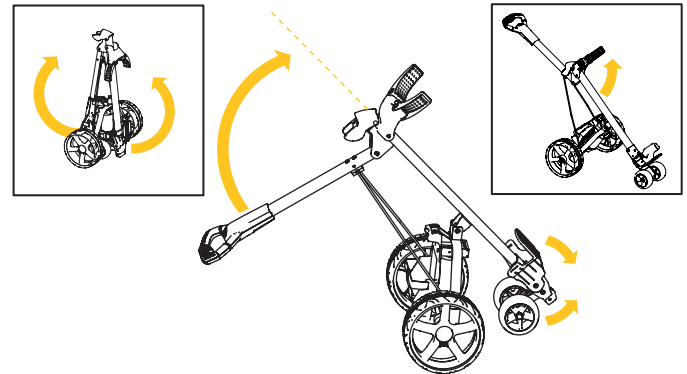

- 4 The handle can be set at two heights. Ensure the latch (Fig A.) has sprung into position to lock the handle at the correct height.

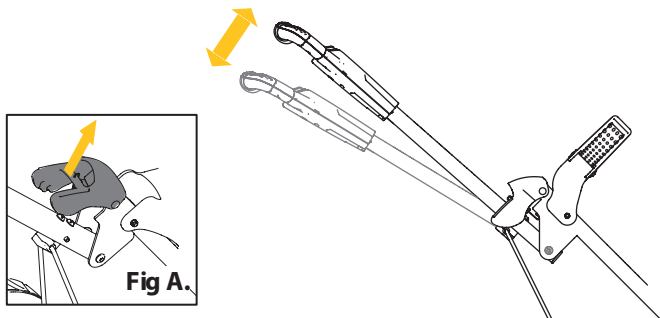

- 5 To open the front wheels simply open the bag stay as shown below. The front wheels will automatically move into position.

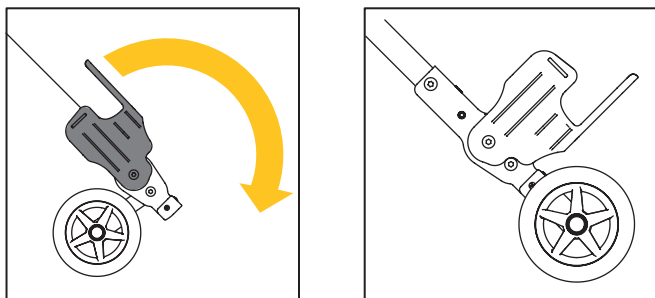

- 6 Next place your battery in position shown below and connect.

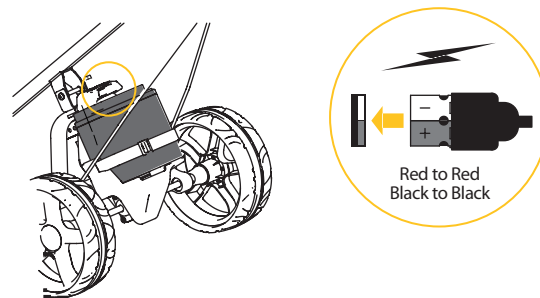

- 7 Turn on the trolley by pressing the power button located on the right side of the handle tube.

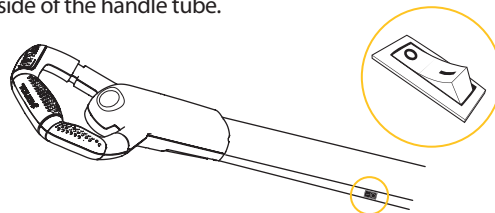

- 8 To start the trolley pull back all the way on the handle, the trolley is now ready to go. Move the handle forward to increase the speed of the trolley and pull back to decrease.

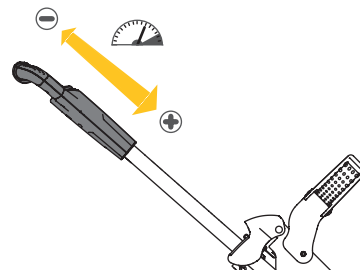

# Troubleshooting Guide

**1 Problem:** My trolley doesn't start

## Solution

- 1:1. Ensure the switch is turned on.
- 1:2. Check your battery is fully charged and connected correctly.
- 1:3. Pull the handle all the way back to the "stop" position and push it forward again.
- 1:4. Check all the external leads are connected.

**If the above doesn't solve the problem contact your nearest service agent.**

**2 Problem:** My trolley will not stop

## Solution

- 2:1. Pull the handle all the way back to the "stop" position.

**If this does not correct the problem, turn the trolley off via the switch, or disconnect the battery and contact your nearest service agent.**

**3 Problem:** The lower bag stay gear mechanism is jammed or does not operate

## Solution

- 3:1. Remove any mud or debris clogging the wheel mechanism.

**If the above doesn't solve the problem contact your nearest service agent.**

**4 Problem:** My trolley doesn't run straight

## Solution

- 4:1. Remove any mud or debris clogging the wheel mechanism.
- 4:2. The front wheel alignment can be adjusted using a standard 4mm Hex key also known as an 'Allen Key' (included). There are two hex screws visible by the lower bag stay, one each side, which when tightened or loosened angle the front wheels left to right.
  - 4:2:1. To angle the wheels right loosen the left screw clockwise and then tighten the right screw anti-clockwise.
  - 4:2:2. To angle the wheels left loosen the right screw clockwise and then tighten the left screw anti-clockwise.

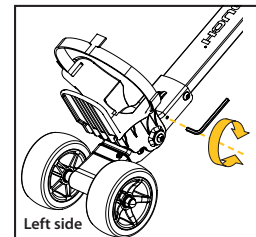
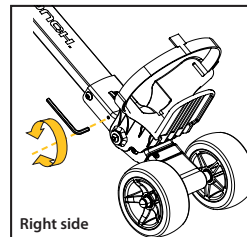

**If the above doesn't solve the problem contact your nearest service agent.**

To find your nearest service agent visit [www.powakaddy.com](http://www.powakaddy.com)

# Quick Start Guide

Please follow these instructions to ensure the correct setup and use of your new electric trolley.

For further information please contact us below or visit our website [www.powakaddy.com](http://www.powakaddy.com)

PowaKaddy International Ltd  
Castle Road  
Sittingbourne  
Kent  
ME10 3RN

[sales@powakaddy.com](mailto:sales@powakaddy.com)

+ 44 (0) 1795 473 555

1

**\*You will need to put your battery on charge straight away.\***

Before you play a round it will need a full 12 hour charge minimum.

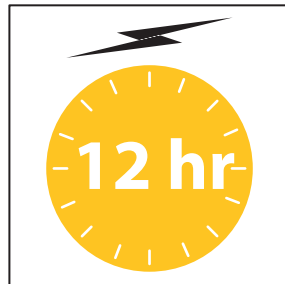
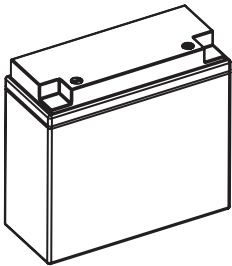

2

Next fit your wheels; simply slide the wheel onto the spindle, press the yellow button and click home.

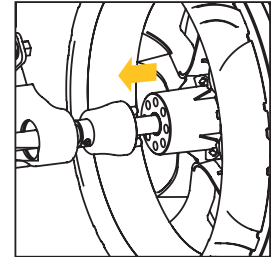
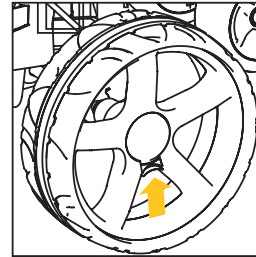

2a

## Wheel Positions

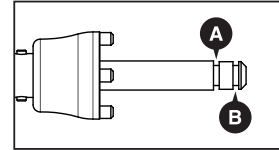

**Groove A.** Wheels will be powered by the motor.

**Groove B.** Wheels will be free wheeling and not powered by the motor.

3

To unfold the trolley, pull the handle up in one motion. The trolley will unfold, at this point the bag stay can be raised.

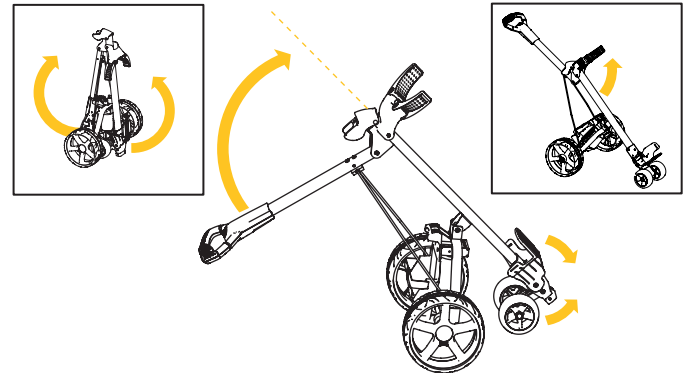

- 4 The handle can be set at two heights. Ensure the latch (Fig A.) has sprung into position to lock the handle at the correct height.

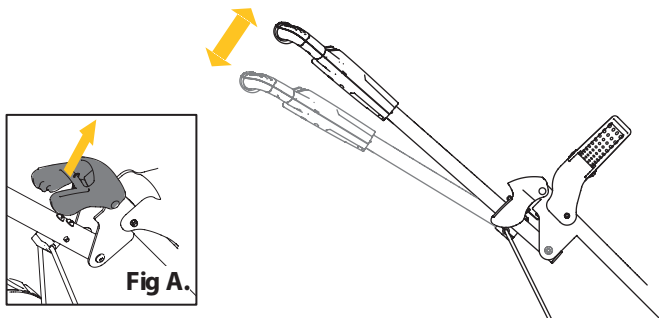

- 5 To open the front wheels simply open the bag stay as shown below. The front wheels will automatically move into position.

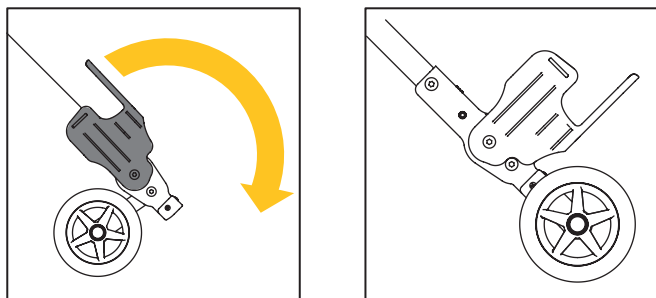

- 6 Next place your battery in position shown below and connect.

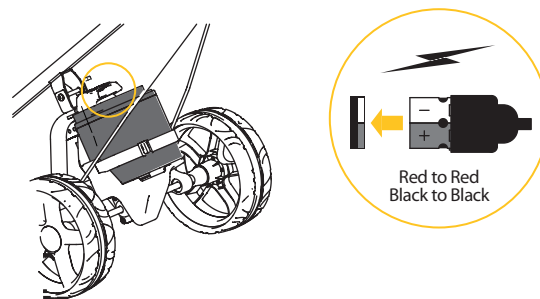

- 7 Turn on the trolley by pressing the power button located on the right side of the handle tube.

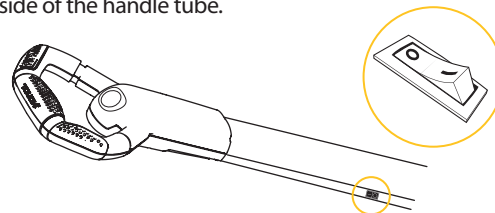

- 8 To start the trolley pull back all the way on the handle, the trolley is now ready to go. Move the handle forward to increase the speed of the trolley and pull back to decrease.

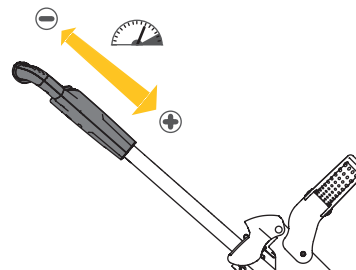

# Troubleshooting Guide

**1 Problem:** My trolley doesn't start

## Solution

- 1:1. Ensure the switch is turned on.
- 1:2. Check your battery is fully charged and connected correctly.
- 1:3. Pull the handle all the way back to the "stop" position and push it forward again.
- 1:4. Check all the external leads are connected.

**If the above doesn't solve the problem contact your nearest service agent.**

**2 Problem:** My trolley will not stop

## Solution

- 2:1. Pull the handle all the way back to the "stop" position.

**If this does not correct the problem, turn the trolley off via the switch, or disconnect the battery and contact your nearest service agent.**

**3 Problem:** The lower bag stay gear mechanism is jammed or does not operate

## Solution

- 3:1. Remove any mud or debris clogging the wheel mechanism.

**If the above doesn't solve the problem contact your nearest service agent.**

**4 Problem:** My trolley doesn't run straight

## Solution

- 4:1. Remove any mud or debris clogging the wheel mechanism.
- 4:2. The front wheel alignment can be adjusted using a standard 4mm Hex key also known as an 'Allen Key' (included). There are two hex screws visible by the lower bag stay, one each side, which when tightened or loosened angle the front wheels left to right.

*4:2:1. To angle the wheels right loosen the left screw clockwise and then tighten the right screw anti-clockwise.*

*4:2:2. To angle the wheels left loosen the right screw clockwise and then tighten the left screw anti-clockwise.*

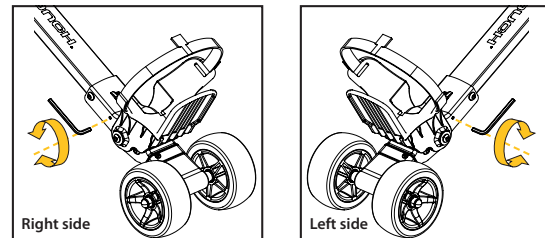

**If the above doesn't solve the problem contact your nearest service agent.**

To find your nearest service agent visit [www.powakaddy.com](http://www.powakaddy.com)

**PGA**  
Official Supplier



**ENGLISH GOLF UNION**  
Official Partner